

REFLECTION



The Essence of Elegance!



The Essence of Elegance

Designbewusst, ausgefeilt im Detail, eine große Auswahl unterschiedlicher Modelle für jeden Geschmack und jeden Dekor.

Die unbeleuchteten Spiegel von Aliseo wurden entwickelt, um den hohen Erwartungen der Hoteliers von heute und denen ihrer Gäste zu entsprechen: perfekt in Funktion und Design mit viel Liebe zum Detail, elegant und zeitlos.

Design driven and beautifully detailed, Aliseo's unlighted mirrors are engineered to meet the demanding expectation of today's hoteliers and their guests. An impressive array of distinctive designs for everyone's taste and bathroom décor.

The Power of REFLECTION

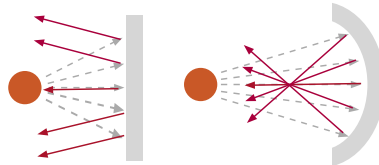

Spiegel - und wie sie vergrößern

Reflektion: Bilder werden vom Glas reflektiert aufgrund des silbernen Nitratanstrichs, der einfallendes Licht abstrahlt.

Konkav-Vergrößerung: 3-fach-Vergrößerung ist am sinnvollsten - je höher die Vergrößerung, desto höher die Verzerrung.

- Die Krümmung der Linse bestimmt den Grad der Vergrößerung.
- Je größer die Krümmung, desto höher die Vergrößerung.
- Je größer der Durchmesser der Linse, desto höher die Verzerrung.

Mirrors and how they magnify

Reflection: Images are reflections off glass. The silver nitrate coating reflects visible light radiation

Concave Magnification: 3x magnification is the most serviceable - the higher the magnification the higher the distortion.

- The curvature of the lens determines the degree of magnification
- The more the curvature, the higher the magnification and distortion
- As the diameter of the lens increases, the distortion increases as well.



THE MINIMALISTS

Cosmo Minimalist

Cosmo Minimalist ist die Essenz puristischer Formgebung. Die konsequente geometrische Linienführung ist ein ausdrucksstarkes "Statement" für Harmonie und Eleganz.

"More than meets the Eye" – The Aliseo Advantage

- **Sichere Befestigung**
 - Separate Montageeinheit
 - Maximale Stabilität
 - Diebstahlschutz - keine sichtbaren Schrauben
 - Perfekt in Funktion und Design
- **Langlebige Chromoberfläche**

Cosmo Minimalist

Elegant essentials in a selection of minimalist designs. Stylistic simplicity in a harmony of clean shapes and geometric designs.

"More than meets the Eye" – The Aliseo Advantage

- **Secure Mounting**
 - Separate mounting bracket
 - Maximum stability
 - Theft proof - no visible screws
 - An elegant finished appearance
- **Fine chrome finish**

"MORE than meets the Eye"



Cosmo Minimalist

- Leichte Ausrichtung
Fingertip adjustment

COSMO MINIMALIST

Schwenkarm	Single arm
3-fach-Vergrößerung	3x magnification
Verdeckte Montageeinheit	Covered backplate
Kippgelenk	Full pivotal adjustment

Art.	Ausführung	Durchmesser
Art.	Finish	Diameter
020563	chrom	160 x 240 mm
020563	chrome	160 x 240 mm

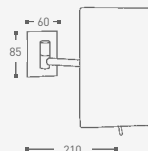

MINIMALIST

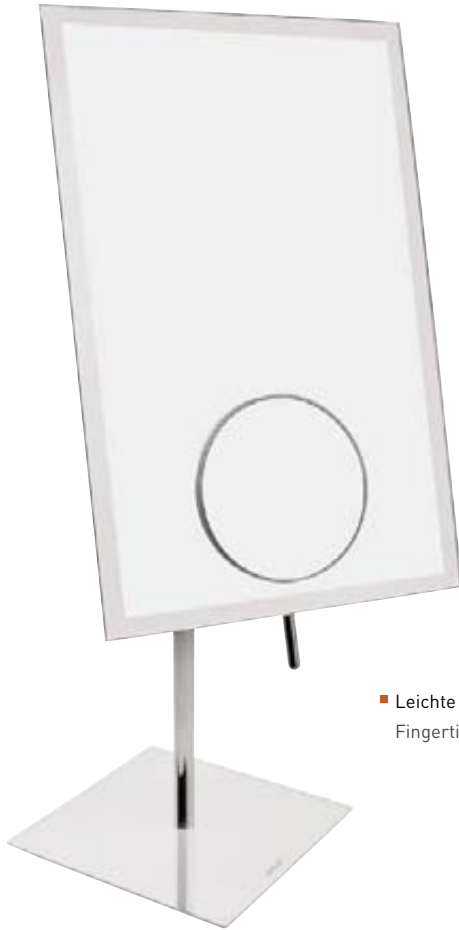

■ Langlebige Chromoberfläche
Fine chrome finish

■ 10-fach-Vergrößerungsausschnitt
10 x circular insert

■ Leichte Ausrichtung
Fingertip adjustment



COSMO MINIMALIST

Standmodell
Planspiegel mit 10-fach-
Vergrößerungsausschnitt
Facettenschliff
Kugelgelenk

Free standing
Plain mirror with
10x circular insert
Facette cut
Full pivotal adjustment

Art.	Ausführung	Durchmesser
Art.	Finish	Diameter
020586	chrom	200 x 300 mm
020586	chrome	200 x 300 mm

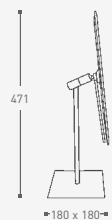

"MORE than meets the Eye"



- Langlebige Chromoberfläche
Fine chrome finish

- Leichte Ausrichtung
Fingertip adjustment



COSMO MINIMALIST

Standmodell
3-fach-Vergrößerung
Kugelgelenk

Free standing
3x magnification
Full pivotal adjustment

Art.	Ausführung	Durchmesser
Art.	Finish	Diameter
020564	chrom	160 x 240 mm
020564	chrome	160 x 240 mm

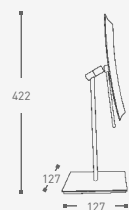

MINIMALIST

"MORE than meets the Eye"

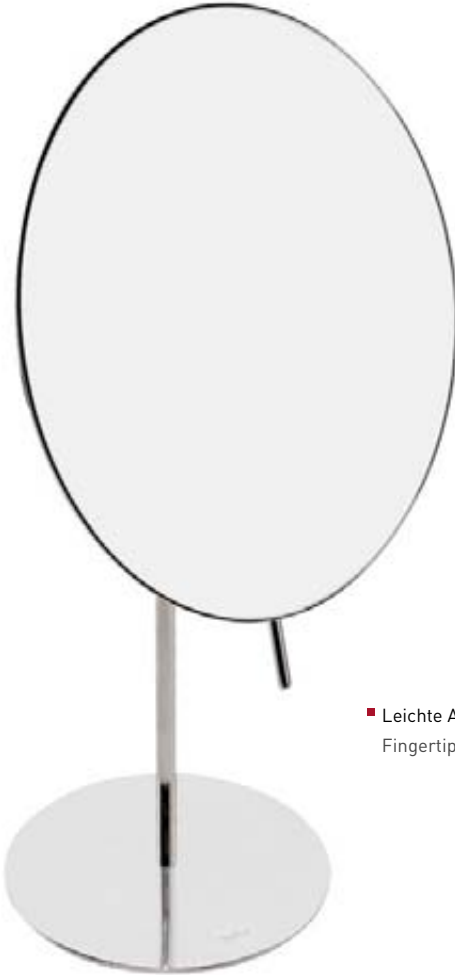

- Langlebige Chromoberfläche
Fine chrome finish

- Leichte Ausrichtung
Fingertip adjustment



COSMO MINIMALIST

Standmodell
3-fach-Vergrößerung
Kugelgelenk

Free standing
3x magnification
Full pivotal adjustment

Art.	Ausführung	Durchmesser
Art.	Finish	Diameter
020488	chrom	ø 200 mm
020488	chrome	ø 200 mm



- Langlebige Chromoberfläche
Fine chrome finish

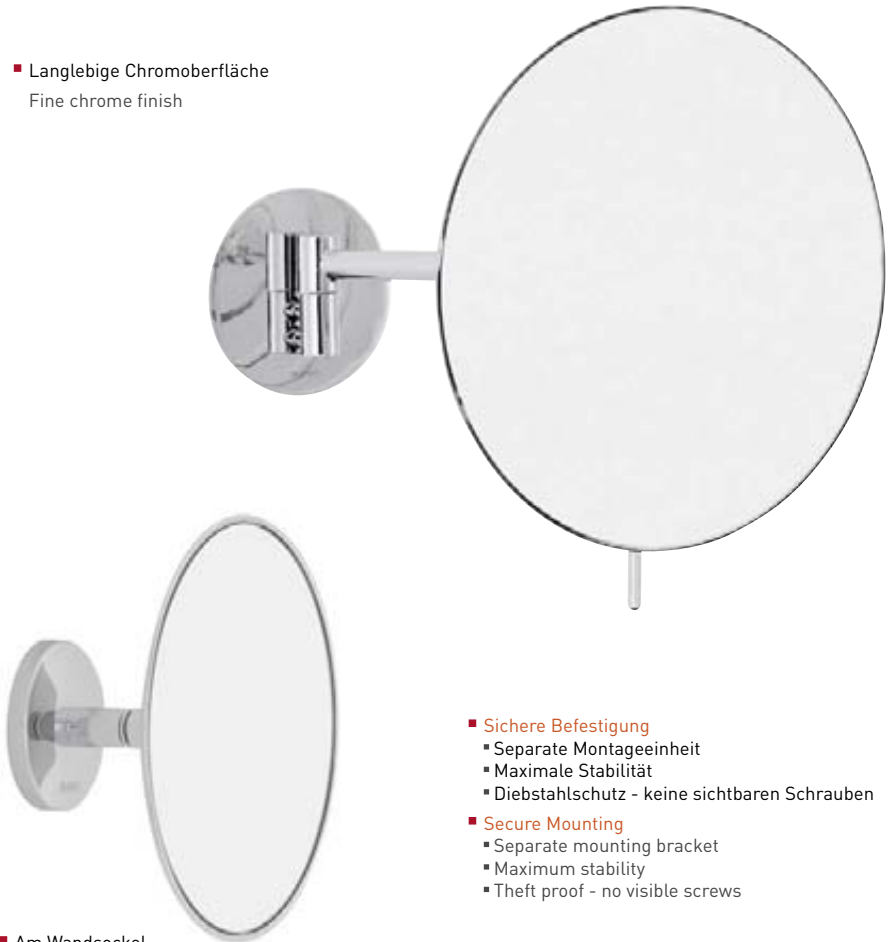

- Am Wandsockel
Wall mount

- **Sichere Befestigung**
 - Separate Montageeinheit
 - Maximale Stabilität
 - Diebstahlschutz - keine sichtbaren Schrauben
- **Secure Mounting**
 - Separate mounting bracket
 - Maximum stability
 - Theft proof - no visible screws

COSMO MINIMALIST

Schwenkarm und Wandsockel
3-fach-Vergrößerung
Verdeckte Montageeinheit
Kipp-/Kugelgelenk

Single arm and wall mount
3x magnification
Covered backplate
Full pivotal adjustment

Art.	Ausführung	Durchmesser
Art.	Finish	Diameter
020607	Schwenkarm	ø 200 mm
020631	Wandsockel	ø 143 mm
020607	Single arm	ø 200 mm
020631	Wall mount	ø 143 mm

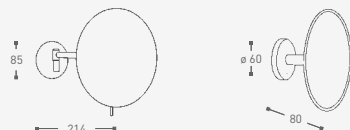



Cosmo Cubik

Cosmopolitan Design! Das elegante, geradlinige Design und eine umfangreiche Modellvielfalt zeichnen die Serie Cosmo Cubik aus. Eine Mischung aus Kraft und Minimalismus.

“More than meets the Eye” – The Aliseo Advantage

- **Sichere Befestigung**
 - Separate Montageeinheit
 - Maximale Stabilität
 - Diebstahlschutz - keine sichtbaren Schrauben
 - Perfekt in Funktion und Design
- **Langlebige Chromoberfläche**

Cosmo Cubik

Casual elegance in a distinctive Cubik motif. Solid bold physique defined by straight powerful lines. An blend of strength and minimalist design.

“More than meets the Eye” – The Aliseo Advantage

- **Secure Mounting**
 - Separate mounting bracket
 - Maximum stability
 - Theft proof - no visible screws
 - An elegant finished appearance
- **Fine chrome finish**

“MORE than meets the Eye”

Cosmo Cubik



- Langlebige Chromoberfläche
Fine chrome finish

COSMO CUBIK

Verkürzter Doppelschwenkarm
Plan- und 3-fach-Vergrößerung
Verdeckte Montageeinheit

Shortened twin arm
Plain and 3x magnification
Covered backplate

Art.	Ausführung	Durchmesser
Art.	Finish	Diameter
020604	chrom	200 x 200 mm
020604	chrom	200 x 200 mm

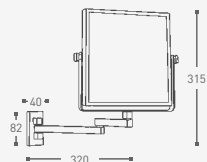

CUBIK



- Modernes quadratisches Design
Modern square design

- Langlebige Chromoberfläche
Fine chrome finish

COSMO CUBIK

Standmodell
Plan- und 3-fach-Vergrößerung

Free standing
Plain and 3x magnification

Art.	Ausführung	Durchmesser
Art.	Finish	Diameter
020603	chrom	200 x 200 mm
020603	chrome	200 x 200 mm

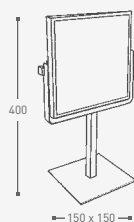

Cosmo Cubik



- Gesicherte Befestigung an der Wand durch verdeckte Montageeinheit
Secured to the wall by a covered backplate

- Verstärktes Gelenk erhöht Beständigkeit und Langlebigkeit
Reinforced pivot pin adds strength and durability

- Diebstahlschutz - keine sichtbaren Schrauben
Theft proof - No visible screws



COSMO CUBIK

Schwenkarm
Plan- und 3-fach-Vergrößerung
Verdeckte Montageeinheit

Single arm
Plain and 3x magnification
Covered backplate

Art.	Ausführung	Durchmesser
Art.	Finish	Diameter
020605	Schwenkarm	200 x 200 mm
020605	Single arm	chrome 200 x 200 mm

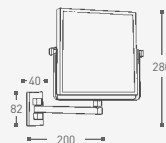



- Wandmontage
Wall mount



COSMO CUBIK

Wandmontage
Plan- und 3-fach-Vergrößerung

Wall mount
Plain and 3x magnification

Art.	Ausführung	Durchmesser
Art.	Finish	Diameter
020608	chrom	200 x 200 mm
020608	chrome	200 x 200 mm

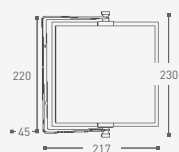

- Langlebige Chromoberfläche
Fine chrome finish

Cosmo Cubik



- Höhenverstellbarer Gleiter
Sure-grip lock-in system



COSMO CUBIK

Wandstange 'QUARZO'
3-fach-Vergrößerung
Verdeckte Schrauben
Kugelgelenk

Wall bar 'QUARZO'
3x magnification
Covered screws
Full pivotal adjustment

Art.	Ausführung	Durchmesser
Art.	Finish	Diameter
020577	chrom	215 x 215 mm
020577	chrome	215 x 215 mm



Concierge Collection

Spiegel - und wie sie vergrößern

*Reflektion: Bilder werden vom Glas reflektiert aufgrund des silbernen Nitratanstrichs, der einfallendes Licht abstrahlt.
Konkav-Vergrößerung: 3-fach-Vergrößerung ist am sinnvollsten - je höher die Vergrößerung, desto höher die Verzerrung.*

Mirrors and how they magnify

*Reflection: Images are reflections off glass. The silver nitrate coating reflects visible light radiation
Concave Magnification: 3x magnification is the most serviceable - the higher the magnification the higher the distortion.*

The Power of REFLECTION

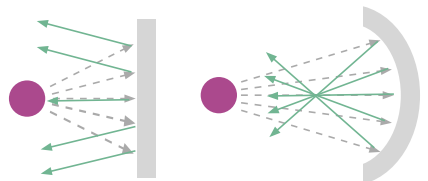

“MORE than meets the Eye”



- Langlebige Chromoberfläche
Fine chrome finish

- Space Saving - Multiflex Fold-Away Design



LUNA

Schwenkarm	Single/twin arm
3-fach-Vergrößerung	3x magnification
Verdeckte Montageeinheit	Covered backplate
Doppelwalzengelenk	Full pivotal adjustment

Art. Art.	Ausführung Finish	Durchmesser Diameter
Am Schwenkarm		
020598	chrom	ø 240 mm
Am Doppel-Schwenkarm		
020599	chrom	ø 240 mm
On single arm		
020598	chrome	ø 240 mm
On Twin arm		
020599	chrome	ø 240 mm

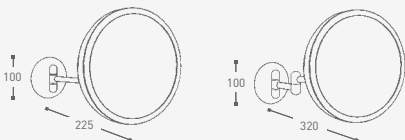

CONCIERGE COLLECTION

- Langlebige Chromoberfläche

Fine chrome finish



- Verstärktes Gelenk erhöht Beständigkeit und Langlebigkeit

Reinforced pivot pin adds strength and durability



- Diebstahlschutz - keine sichtbaren Schrauben

Theft proof - No visible screws

Schwenkarm
Plan- und 3-fach-Vergrößerung
Verdeckte Montageeinheit

Single arm
Plain and 3x magnification
Covered backplate

Art.	Ausführung	Durchmesser
Art.	Finish	Diameter
020506	chrom	ø 200 mm
020506	chrome	ø 200 mm

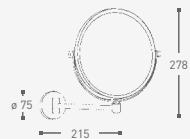

"MORE than meets the Eye"

- Langlebige Chromoberfläche
Fine chrome finish



- Sichere Befestigung
 - Separate Montageeinheit
 - Maximale Stabilität
 - Perfekt in Funktion und Design
- Secure Mounting
 - Separate mounting bracket
 - Maximum stability
 - A finished elegant appearance

Doppel-Schwenkarm
Plan- und 3-fach-Vergrößerung
Verdeckte Montageeinheit

Twin arm
Plain and 3x magnification
Covered backplate

Art.	Ausführung	Durchmesser
Art.	Finish	Diameter
020507	chrom	ø 200 mm
020507	chrome	ø 200 mm

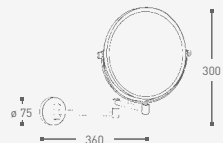



- Zum Aufkleben
Adhesive



- Langlebige Chromoberfläche
Fine chrome finish



Zum Aufkleben
3-fach-Vergrößerung
Mit Kunststoffrahmen

Adhesive
3x magnification
Mit Kunststoffrahmen

Standmodell
Plan- und
3-fach-Vergrößerung

Free standing
Plain and
3x magnification

Art.	Ausführung	Durchmesser
Art.	Finish	Diameter
020001	glasklar	ø 170 mm
020001	clear	ø 170 mm

Art.	Ausführung	Durchmesser
Art.	Finish	Diameter
020499	chrom	ø 200 mm
020499	chrome	ø 200 mm

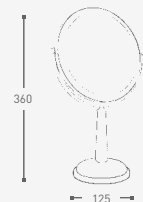

"MORE than meets the Eye"

- Langlebige Chromoberfläche
Fine chrome finish



- Separate und verdeckte Montageeinheit für maximale Stabilität
Independent mounting bracket with cover plate for maximum stability

- Verdeckte Montageeinheit - Diebstahlschutz
Covered backplate - theft proof

- Verstärktes Gelenk erhöht Beständigkeit und Langlebigkeit
Reinforced pivot pin adds strength and durability



Schwenkarm
Plan- und 3-fach-Vergrößerung
Verdeckte Montageeinheit

Single arm
Plain and 3x magnification
Covered backplate

Art.	Ausführung	Durchmesser
Art.	Finish	Diameter
020486	chrom	ø 200 mm
020486	chrome	ø 200 mm

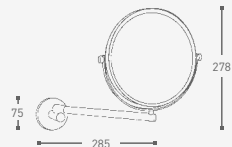



- Langlebige Chromoberfläche
Fine chrome finish



- Höhenverstellbar
Height adjustable

- Sichere Befestigung
 - Separate Montageeinheit
 - Erhöhte Stabilität
 - Diebstahlschutz - keine sichtbaren Schrauben
- Secure Mounting
 - Separate mounting bracket
 - Increased stability
 - Theft proof - no visible screws

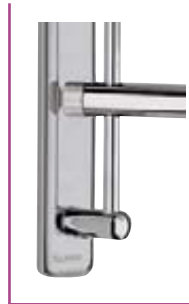

Schwenkarm	Single arm
Plan- und 3-fach-Vergrößerung	Plain and 3x magnification
Höhenverstellbar	Height adjustable
Verdeckte Montageeinheit	Covered backplate

Art.	Ausführung	Durchmesser
Art.	Finish	Diameter
020597	chrom	ø 200 mm
020597	chrome	ø 200 mm

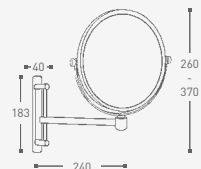

CONCIERGE COLLECTION

- Langlebige Chromoberfläche
Fine chrome finish



- Diebstahlschutz - keine sichtbaren Schrauben
Theft proof - No visible screws

"MORE than meets the Eye"

- Gesicherte Befestigung an der Wand durch verdeckte Montageeinheit
Secured to the wall by a covered backplate



Schwenkarm
Plan- und 3-fach-Vergrößerung
Verdeckte Schrauben

Single/twin arm
Plain and 3x magnification
Covered Screws

Art. Art.	Ausführung Finish	Durchmesser Diameter
Am Schwenkarm 020490	chrom	ø 200 mm
Am verkürzten Doppel-Schwenkarm 020491	chrom	ø 200 mm
Am Doppel-Schwenkarm 020492	chrom	ø 200 mm
On single arm 020490	chrome	ø 200 mm
On shortened twin arm 020491	chrome	ø 200 mm
On twin arm 020492	chrome	ø 200 mm

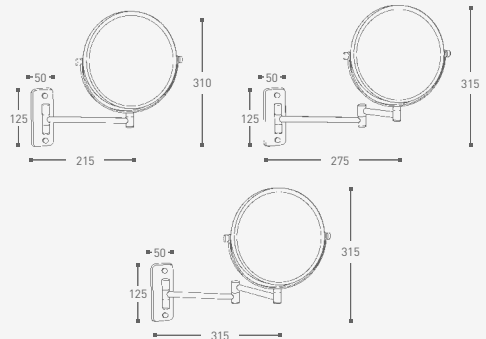

- Gesicherte Befestigung an der Wand durch verdeckte Montageeinheit
Secured to the wall by a covered backplate

- Verstärktes Gelenk erhöht Beständigkeit und Langlebigkeit
Reinforced pivot pin adds strength and durability



- Diebstahlschutz - keine sichtbaren Schrauben
Theft proof - No visible screws



- Langlebige Chromoberfläche
Fine chrome finish

Schwenkarm
Plan- und 3-fach-Vergrößerung
Verdeckte Montageeinheit

Single/twin arm
Plain and 3x magnification
Covered backplate

Art. Art.	Ausführung Finish	Durchmesser Diameter
Am einfachen Schwenkarm		
020569	chrom	ø 200 mm
Am verkürzten Doppel-Schwenkarm		
020570	chrom	ø 200 mm
On single arm		
020569	chrome	ø 200 mm
On shortened twin arm		
020570	chrome	ø 200 mm

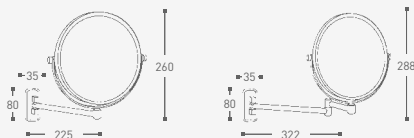

CONCIERGE COLLECTION



Seatra



Saba

- Langlebige Chromoberfläche
Fine chrome finish



- Höhenverstellbare Gleiter
Sure-grip lock-in system



- Höhenverstellbarer Gleiter
Sure-grip lock-in system



Slim



Wandstange
3-fach-Vergrößerung
Verdeckte Schrauben
Kugelgelenk

Wall bar
3x magnification
Covered Screws
Full pivotal adjustment

Art.		Ausführung	Durchmesser
Art.		Finish	Diameter
020614	SLIM	chrom	ø 200 mm
020047	SEATRA	chrom	ø 230 mm
020011	SABA *	chrom	ø 190 mm
020012	SABA *	chrom	ø 220 mm
020614	SLIM	chrome	ø 200 mm
020047	SEATRA	chrome	ø 230 mm
020011	SABA *	chrome	ø 190 mm
020012	SABA *	chrome	ø 220 mm

* SABA: Material Spiegel: ABS-Kunststoff

* SABA: Material mirror: ABS-plastic

- Langlebige Chromoberfläche
Fine chrome finish

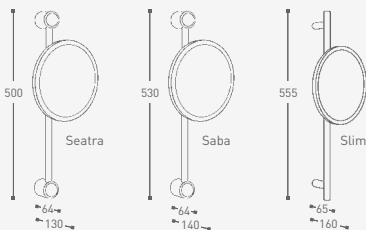



- Langlebige Chromoberfläche
Fine chrome finish



- Stabile Doppelschere
Sturdy double-scissor design

Doppelscherenarm
Plan- und 3-fach-Vergrößerung
Verdeckte Schrauben

Twin scissor arm
Plain and 3x magnification
Covered screws

Art.	Ausführung	Durchmesser
Art.	Finish	Diameter
020458	chrom	ø 200 mm
020458	chrome	ø 200 mm

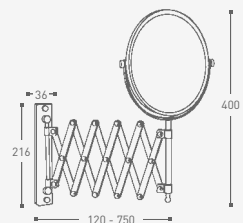



- Langlebige Chromoberfläche
Fine chrome finish

Standmodell
Plan- und 3-fach-Vergrößerung

Free standing
Plain and 3x magnification

Art.	Ausführung	Durchmesser
Art.	Finish	Diameter
020496	chrom	ø 250 mm
020496	chrome	ø 250 mm



arpaitalia
hotel supplies

www.arpaItalia.com

Arpa Italia Srl, Via delle Betulle 6, I - 61100 Pesaro (PU)
Tel: +39 0721 405274 - Fax: +39 0721 259164 - Email: info@arpaItalia.com